

SUB-D09M-180Universal Pin version

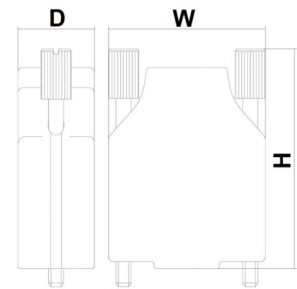

The pin version SUB-D09M-180Universal was specially designed for universal use.

The great advantage of the design is that the spring-loaded terminals make assembly easy and can be done under field conditions. In addition, the robust metal housing offers the possibility of laying the cable shield over a large area and thus ensuring a high level of shielding against EMC interference.



Key commercial data

Packing unit	1 pc
Weight per piece (excluding packing)	56g
Weight per piece (including packing)	66g
Country of origin	Germany

Technical data mechanically

Width (W)	32mm
Height (H)	58mm
Depth (D)	15mm
Ambient temperature (operation)	0°C ... 50°C
Ambient temperature (storage/transport)	-20°C ... 70°C
Relative humidity	90% without condensation
Mounting position	any
Housing type	TE D-Sub Backshells Series
Housing material	Zinc
Thread size of the locking screw	4-40 UNC
Screw drive of the locking screw	 0,6×3,5mm
Cable diameter	Ø4mm ... Ø10mm
Contact material of the connector	Brass
Contact coating of the connector	Shiny gold plated

SUB-D09M-180Universal
Pin version

Technical data electric

Nominal voltage U_N	48V AC/DC
Nominal current I_N	1,25A
Protection class	IP20
Connection data PCB terminal	
Connection type	Push-in spring connection
Conductor cross section solid	0,14mm ² ... 0,5mm ²
Conductor cross section flexible	0,25mm ² ... 0,5mm ²
Conductor cross section with ferrule, without plastic sleeve	0,25mm ² ... 0,5mm ²
Conductor cross section with ferrule, with plastic sleeve	0,25mm ² ... 0,34mm ²
Stripping length	6mm
Connection data connector	
Connection type	SUB-D 9-pol pin

Standards and Regulations

Standards/regulations	EN 50581: 02/13
-----------------------	-----------------

PIN assignment

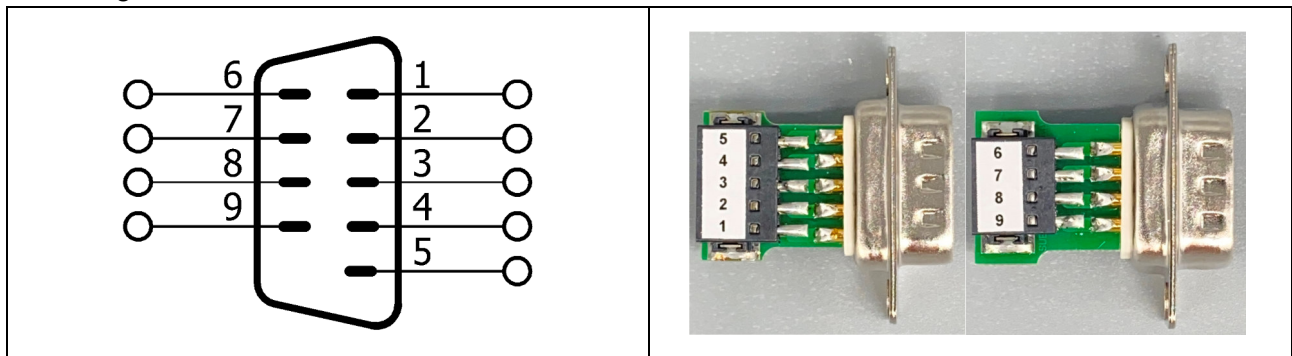

SUB-D09M-180Universal Pin version

Pictures

